

DESCRIPTION

The All-Pro RL706830E26WBS is a retrofit LED Module-Trim for 5" and 6" aperture recessed downlights. The RL706830E26WBS is designed for use with compatible 5" and 6" housings including the Halo H25, H5, H27, H7, H7U series and All-Pro ET/EI500, ET/EI2700, ET/EI700. The RL7 with integral LED driver offers 120 volt dimming capability. The RL7 lens provides uniform illumination and wet location listing. The RL7 die-cast construction makes any housing AIR-TITE for added HVAC savings and code compliance.

Catalog #		Type
Project		
Comments		Date
Prepared by		

SPECIFICATION FEATURES

MECHANICAL Module-Trim

- Module construction includes LED, heat sink, reflector, lens, baffle and trim ring
- Durable die-cast aluminum construction
- Heat sink designed to conduct heat away from the LED keeping the junction temperatures below specified maximums, even when installed in insulated ceiling environments
- High Gloss Appliance White paint finish

Lens

- Impact-resistant polycarbonate
- Convex form for lamp-like appearance
- High lumen transmission
- Diffusing for even illumination

MOUNTING

Torsion Spring Brackets

- Precision formed steel torsion spring brackets secure torsion springs to fit compatible housings with torsion spring mounting tabs.
- **Accessory (included):** 5" & 6" Friction Blade Kit: Stainless steel friction blades provide alternative to torsion springs for retrofit in 5" and 6" housings without torsion spring mounting tabs.
- Friction blade design allows the RL7 to be installed in any position within the housing aperture (360 degrees).

Housing Compatibility

See Housing Compatibility section.

LED

- 636 lumens
- Color Temperature: 3000°K
- CRI: 81
- Lumen Maintenance: L70/50 70% lumens / 50,000 hours
- Efficacy 43.47 Lumens per Watt
- LED is a chip on board design consisting of a multiple LED package to create one virtual light source for a productive "cone of light"

ELECTRICAL Power Connections

- E26 medium screw-base Edison connector provides easy retrofit of incandescent housings.

Ground Connection

- Separate grounding cable included on the RL7 module for attachment to the housing during installation.

LED Driver

- Dimmable driver is a120 Volt, high efficiency, electronic power supply providing DC power to the LED.
- Driver meets FCC EMI/RFI Consumer Level limits for use in residential and commercial installations.
- Driver features power factor >.90, THD <20% and has integral thermal protection in the event of over temperature or internal failure.
- Driver is specifically designed for compatibility with RL7 series LED.
- Driver mounts externally to the module, allowing future replacement, if needed.

Dimming

- The RL7 LED is dimmable to 15% with standard 120V electronic low voltage dimmers (recommended), and many incandescent / magnetic low voltage dimmers; and dims to 5% using dimmers with low end trim adjustment.
- **Note:** Standard incandescent dimmers require a minimum load of typically >40 watts on the circuit for full range dimming performance (four LED modules).
- **Note:** For dimming with digital (smart) multi-location dimmers or when dimming fewer than four LED modules, electronic low voltage dimmers are required (ELV dimmers need a neutral connection in the wallbox).
- Refer to dimming application notes, and refer to dimmer manufacturers for compatibility.

Warranty

Cooper Lighting provides a three year limited warranty on RL7 LED.

COMPLIANCE Labels

- UL/cUL Listed
- UL/cUL Listed for Damp Location
- UL/cUL Listed for Wet Location – Shower Applications
- May be installed in housings in direct contact with air-permeable insulation and combustible material

Qualification

- ENERGY STAR® qualified
- Can be used for International Energy Conservation Code luminaire (IECC) high efficacy compliance

IC and AIR-TITE™

Certified under ASTM-E283 and listed UL/cUL 1598 with compatible housings, may be used to meet insulated ceiling and restricted air-flow requirements such as:

- Washington State Energy Code
- International Energy Conservation Code (IECC)
- New York State Energy Conservation Construction Code (NY-ECCC)
- State of California Title 24 "Recessed Luminaires in Insulated Ceilings."



RL706830E26WBS

**5-Inch / 6-Inch LED
Recessed Retrofit
Module-Trim
with E26 Medium
Screw-base**

**FOR USE IN
INSULATED CEILING
AND NON-INSULATED
CEILING RATED
HOUSINGS**

**HIGH EFFICACY LED
WITH INTEGRAL
DRIVER - DIMMABLE**

Energy Date (Typical)	
Min. Starting Temp -30°C (-22°F)	Sound Rating: Class A
EM/RFI: FCC Title 47 CFR, Part 15, Class B (Consumer)	
Input Frequency: 50/60Hz	Power Factor: >0.90
THD: <20%	Input Voltage: 120V
Rated Wattage: 15W max.	Input Power: 14.5W
	Input Current: 121mA
Driver Compliance: UL60950, LPS rated	
Maximum IC (Insulated Ceiling) Ambient Continuous Operating Temperature: 25°C (77°F)	
Maximum Non-IC (NON-Insulated Ceiling) Ambient Continuous Operating Temperature: 40°C (104°F)	
LED Lighting Data	
Lumens: 636	Lumens per watt: 43.47
Correlated Color Temperature (CCT): 3000K	
Color Rendering Index (CRI, Ra): 81	



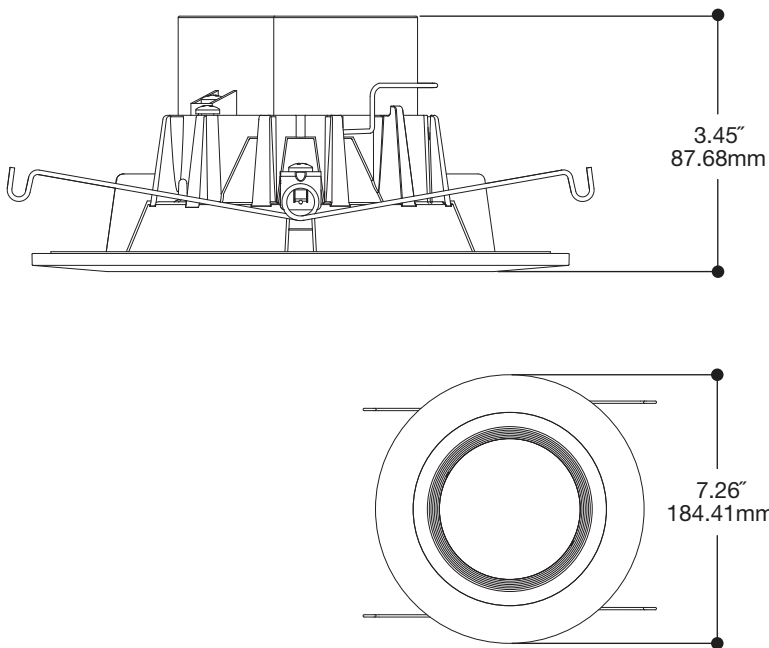

lighting facts ^{CM}	
A Program of the U.S. DOE	
Light Output (Lumens)	636
Watts	14.63
Lumens per Watt (Efficacy)	43
Color Accuracy Color Rendering Index (CRI)	81
Light Color Correlated Color Temperature (CCT)	3027 (Bright White)
<small>All results are according to IESNA LM-79-2008: Approved Method for the Electrical and Photometric Testing of Solid-State Lighting. The U.S. Department of Energy (DOE) verifies product test data and results.</small>	
Visit www.lightingfacts.com for the Label Reference Guide.	
<small>Registration Number: XCJ7-PZXG2Q Model Number: RL706830E26WBS Type: Recessed downlight</small>	

HOUSING COMPATIBILITY

RL706830E26WBS UL/cUL Listed for installation in the following Halo and All-Pro E26 screw based 5" and 6" standard and shallow recessed housings:

HALO: H7ICAT, H7RICAT, H7ICT, H7RICT, H7ICATNB, H7ICTNB, H7T, H7RT, H7TNB, H7TCP, H7UICAT, H7UICAT, H27ICAT, H27RICAT, H27ICT, H27RICT, H27T, H27RT, H5ICAT, H5RICAT, H5T, H5RT, H25ICAT

All-Pro: EI500AT, EI500RAT, ET500, ET500R, EI700AT, EI700RAT, EI700ATNB, EI700, EI700R, EI700ATNB, EI700NB, ET700, ET700R, EI700U, EI700UAT, EI2700AT, EI2700, EI2700R, ET2700, ET2700R

RL706830E26WBS UL Classified for retrofit in the following 5" and 6" recessed housings:

Juno: IC22, IC22R, IC22W, IC22S, IC23, IC23W, IC21, IC21R, TC2, TC2R, IC20, IC20R, IC25, IC25R, IC25W, IC25S, TC20, TC20R

Capri: CR1, PR1, QL1, R9ASIC

Lightolier: 1104ICS*, 1104ICR*, 1104SIC*, 1104SICR*, 1004ICS*, 1004ICR*, 1004SIC*, 1004SICR*

Lightolier: 1104ICX - Requires installation of ML7RAB retrofit adapter band accessory (not included).

Progress: P87-AT*, P86TG

Lithonia: L7X, L7XP

Thomas: PS1, R9ASIC/PS9RM

Prescolite: IBXS

Commercial Electric: H3, H17, H18

Elco: EL7ICA

* Requires replacement of torsion springs with included friction clips.

ORDERING INFORMATION

SAMPLE NUMBER: RL706830E26WBS

Complete unit includes RL7 LED and 5" or 6" compatible housing, ordered separately.

RL7 Module

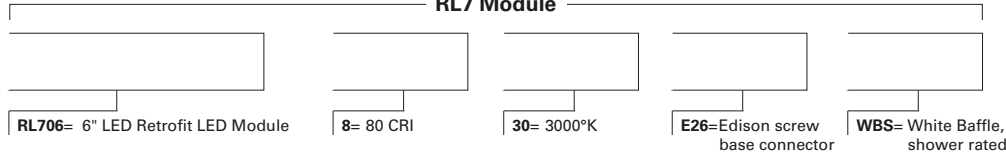

Compatible Halo 5" Incandescent Housings



- H5 & H25=5" Incandescent Housing with E26 screw shell socket**
- H5ICAT=5" Insulated Ceiling, AIR-TITE New Construction Housing**
 - H5RICAT=5" Insulated Ceiling, AIR-TITE Remodel Housing**
 - H5T=5" Non-IC, New Construction Housing**
 - H5RT=5" Non-IC, Remodel Housing**
 - H25ICAT=5" Shallow, Insulated Ceiling, AIR-TITE New Construction Housing**

Compatible Halo 6" Incandescent Housings



- H7 & H27=6" Incandescent Housing with E26 screw shell socket**
- H7ICAT=6" Insulated Ceiling, AIR-TITE New Construction Housing**
 - H7RICAT=6" Insulated Ceiling, AIR-TITE Remodel Housing**
 - H7ICT=6" Insulated Ceiling, New Construction Housing**
 - H7RICT=6" Insulated Ceiling, Remodel Housing**
 - H7ICATNB=6" Insulated Ceiling, AIR-TITE New Construction Housing, No Socket Bracket**
 - H7ICTNB=6" Insulated Ceiling, New Construction Housing, No Socket Bracket**
 - H7T=6" Non-IC, New Construction Housing**
 - H7RT=6" Non-IC, Remodel Housing**
 - H7TNB=6" Non-IC, New Construction Housing, No Socket Bracket**
 - H7TCP=6" Non-IC, AIR-TITE, Chicago Plenum, New Construction/Remodel Housing**
 - H7UICAT=6" Insulated Ceiling, Universal New Construction Housing**
 - H7UICATNB=6" Insulated Ceiling, Universal, AIR-TITE, New Construction Housing**

 - H27ICAT=6" Shallow, Insulated Ceiling, AIR-TITE New Construction Housing**
 - H27RICAT=6" Shallow, Insulated Ceiling, AIR-TITE Remodel Housing**
 - H27ICT=6" Shallow, Insulated Ceiling, New Construction Housing**
 - H27RICT=6" Shallow, Insulated Ceiling, Remodel Housing**
 - H27T=6" Shallow, Non-IC, New Construction Housing**
 - H27RT=6" Shallow, Non-IC, Remodel Housing**

Compatible All-Pro 5" Incandescent Housings



- ET/EI5=5" Incandescent Housing with E26 screw shell socket**
- EI500AT=5" Insulated Ceiling, AIR-TITE New Construction Housing**
 - EI500RAT=5" Insulated Ceiling, AIR-TITE Remodel Housing**

 - ET500=5" Non-IC, New Construction Housing**
 - ET500R=5" Non-IC, Remodel Housing**

Compatible All-Pro 6" Incandescent Housings



- ET/EI7 & ET/EI27=6" Incandescent Housing with E26 screw shell socket**
- EI700AT=6" Insulated Ceiling, AIR-TITE New Construction Housing**
 - EI700RAT=6" Insulated Ceiling, AIR-TITE Remodel Housing**
 - EI700=6" Insulated Ceiling, New Construction Housing**
 - EI700R=6" Insulated Ceiling, Remodel Housing**
 - EI700ATNB=6" Insulated Ceiling, AIR-TITE New Construction Housing, No Socket Bracket**
 - EI700NB=6" Insulated Ceiling, New Construction Housing, No Socket Bracket**

 - ET700=6" Non-IC, New Construction Housing**
 - ET700R=6" Non-IC, Remodel Housing**

 - EI700U=6" Insulated Ceiling, Universal New Construction Housing**
 - EI700UAT=6" Insulated Ceiling, Universal, AIR-TITE, New Construction Housing**

 - EI2700AT=6" Shallow, Insulated Ceiling, AIR-TITE New Construction Housing**
 - EI2700=6" Shallow, Insulated Ceiling, AIR-TITE New Construction Housing**
 - EI2700R=6" Shallow, Insulated Ceiling, AIR-TITE Remodel Housing**

 - ET2700=6" Shallow, Non-IC, New Construction Housing**
 - ET2700R=6" Shallow, Non-IC, Remodel Housing**

Accessories



- OT400P= Oversize White Metal Trim Ring 6" ID x 9-1/4" OD**
- OT403P= Oversize White Plastic Trim Ring 6" ID x 8" OD**
- H277= 300VA Transformer - Steps 277 line voltage down to 120V (see App. Note)**
- H347= 75VA Transformer - Steps 347 line voltage down to 120V (see App. Note)**

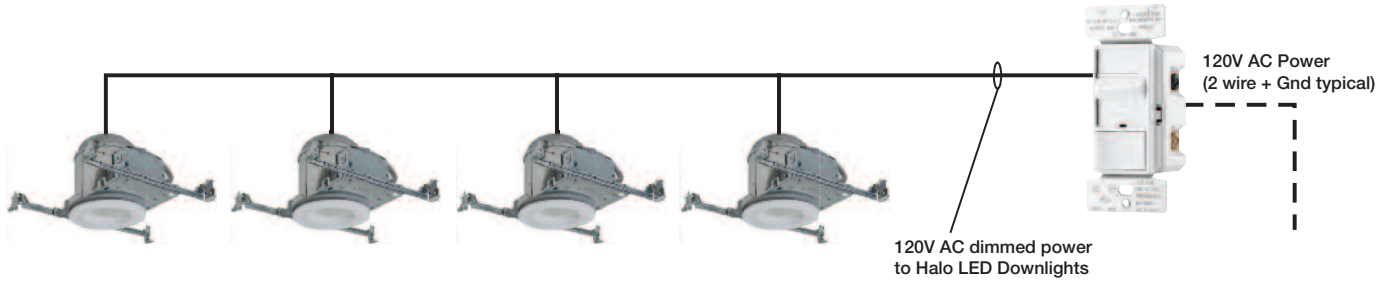

Dimmer Types & Representative List of Manufacturers*

Electronic Low Voltage (ELV) - 120VAC Dimmers

- ELV dimmers provide greater assurance of dimming performance compatibility.*
 - Electronic Low Voltage Reverse Phase (Trailing Edge) Dimmers
 - Minimum Circuit Load of One LED Module, Dimming to 15% (dimming to 5% with select dimmers as noted)
- Require the neutral terminal on the dimmer connected to a neutral in the wall box.*

Lutron

Diva®	DVELV Series
Maestro®	MAELV Series
Nova®	NLV Series
Nova T®	NTELV & NTLV Series
Skylark®	SELV Series
Vierti®	VTELV Series

Leviton

Minimum Brightness Adjustment (Low End Trim), Dimming to 5%

Acenti®	ACE Series (Programmable trim)
IllumiTech™	IPE Series (Manual trim)
Vizia +	VPE Series (Programmable trim)

Incandescent/Magnetic Low Voltage Dimmers (INC/MLV) - 120VAC

- Incandescent / Magnetic L.V. Forward Phase (Leading Edge) Dimmers
- Circuit Load of 4 LED Modules or More, Dimming to 15%
- INC/MLV dimmers are generally compatible and typically provide acceptable dimming results.*

Cooper Controls

iLumin	SC-UN Universal Source Controller Series - Lighting Control Panel System
--------	--

Cooper Wiring Devices

ASPIRE RF®	N/A
ASPIRE™	9530, 9532, 9538, 9540
Decorator Slide®	DI06P, DI10P
Decorator Full-Slide®	SI061, SI06P, SI10P
Toggle®	6441, 6443, 6453
Rotary®	6001, 6013, 6000, 6003, 6020, 6023
Architectural Rotary®	RAI10, RAI15, RAI20

Lutron

Ariadni®	AY/TG Series	Lumea™	LG Series
Ceana™	CN Series	Lyneo™	LX Series
Centurion®	C Series	Nova®	N Series
Dalia™	DL Series	Nova T®	NT/NTB/NTA Series
Diva®	DV Series	Qoto™	Q Series
Glyder®	GL Series	Skylark®	S Series

Leviton

Illumitech™	IPI/RPI Series	Trimatron™	6681/6683/6602
Sureslide™	663 Series	TrueTouch™	6606-ILM

Minimum Brightness Adjustment (Low End Trim), Dimming to 5%

Illumitech™	IP10/IP40/IPM406/IPM10 Series dimmers (Manual trim)
Acenti®	ACI/ACE/ACX/ATI Series (Programmable trim)
Vizia +	VPI/VPE/VPX Series (Programmable trim)

- Universal Wireless Dimmers (Incandescent, Magnetic Low Voltage, Electronic Low Voltage)
- Minimum Circuit Load of Two LED Modules, Dimming to 15%

Watt Stopper

Miro Universal	DRD4 Series Dimmers
	DCD267 Series Dimmers
	DCD68 Series Multilocation - When used with DRD4 or DCD267 series master dimmers

- Incandescent Wireless Dimmers
- Minimum Circuit Load of Five LED Modules, Dimming to 15%

A 15W minimum incandescent load or a neutral in the wall box may be required to reliably dim

Watt Stopper

Miro Incandescent	DRD2 Series Dimmers
	DCD26 Series Dimmers
	DCD68 Series Multilocation - When used with DRD2 or DCD26 series master dimmers

Commercial Integrated Control Systems

Lutron

Commercial Panel Systems	LP-RPM-4A120 Remote Power Module - Adaptive Dimming
--------------------------	---

Whole House Integrated Control Systems

Lutron

Homeworks	HW-RPM-4A-120 Remote Power Module-Adaptive Dimming
	HW-RPM-4V-120 Remote Power Module-Dimming
	HWD-5NE, HRD-5NE Wired Maestro and RF Maestro Local Controls

*Applications Notes

- LED Dimming performance may vary from incandescent dimming. Performance results may vary based upon dimmer model, manufacturer, circuit wiring and circuit loading.
- Dimmer maximum load rating with LED may differ from published Incandescent and Electronic Low Voltage dimmer ratings. Consult dimmer manufacturer for maximum dimmer load with LED.
- For special dimming applications consult dimmer manufacturer or controls specialist (e.g. large multiple circuit installations, many LEDs per circuit, sequenced fades, 277V or 347V circuits powered by step-down transformers, etc.).
- There are no warranties of performance or compatibility implied.
- This is a representative list of dimmers. Refer to dimmer manufacturers for information and LED compatibility.

SPECIAL NOTE:

Incandescent Digital Dimmers (also called Smart or Multi-Location) require an incandescent load. For circuit loads with LED modules only - use electronic low voltage (ELV) dimmers.

Oversize Trim Rings

For use when ceiling opening is irregular or cut too large. The oversized trim ring is installed behind the LED trim ring to mask irregularities or cutout errors of the ceiling opening.

- OT400P = Oversize White Metal Trim Ring 6" ID x 9-1/4" OD
- OT403P = Oversize White Plastic Trim Ring 6" ID x 8" OD

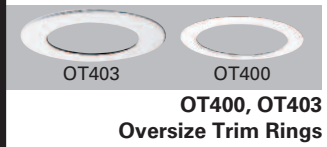

**OT400, OT403
Oversize Trim Rings**

Application Note - H277 and H347 step-down transformers are qualified to drive multiple LED modules on a single circuit in Non-IC construction. Installation of these transformers on individual fixtures on circuits with multiple LED loads is not recommended. H277 is 300VA and qualified to drive up to 15 LED modules. H347 is 75VA and qualified to drive up to 3 LED modules. Installation of individual H277 or H347 transformers on each LED downlight fixture in a multiple LED loaded circuit is not recommended due to resulting multiple inductive currents pulled by each transformer; in this situation the majority of the power would then be reactive (VARS) and not real (WATTS). If H277 or H347 transformers should be used individually on each LED fixture in a single circuit, then that circuit should be sized for lowered power factor as well as increased apparent power on the circuit. H277 and H347 are UL/cUL listed for use with Halo housings: H7T, H7TNB, H7RT, H750T, H750TCP



**H277
277V Step Down
Transformer,
300VA**



**H347
347V Step Down
Transformer,
75VA**

Step Down Transformers

H277= Steps 277 line voltage down to 120 volts. Attaches to knockout on first fixture's junction box in a circuit and is 300VA rated (15 modules max.). H277 is a UL Recognized Component listed under the luminaire UL/cUL listing for Non-IC housings and LED Module.

H347= Steps 347 line voltage down to 120 volts. Attaches to knockout on first fixture's junction box in a circuit and is 75VA rated (3 modules max.). H347 is a CSA/UL Listed Component for use under the luminaire UL/cUL listing with Non-IC housings and a LED Module.

Transformer with Dimmer /Switch on Secondary

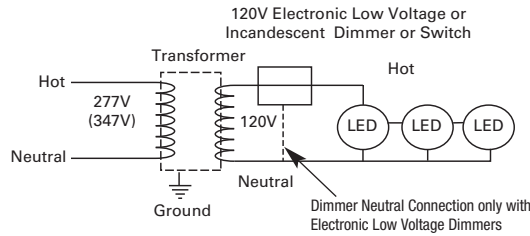

Transformer with Dimmer / Switch on Primary

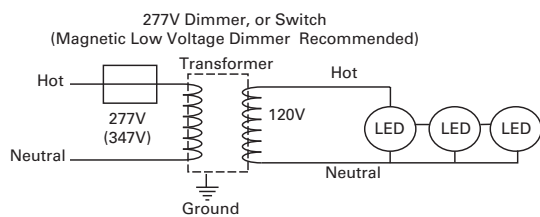

Dimmer or Switch may be on the Primary (277V) OR Secondary (120V) side of the transformer.

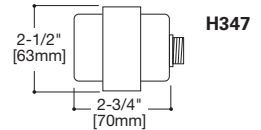
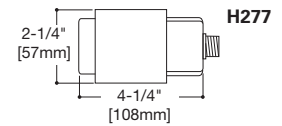

Transformer Load - H277 (300VA)

1. H277 Transformer at full loading consumes a maximum of 16W of power
2. When dimmer or switch is on the secondary (120V) side of the transformer, power is consumed by the transformer when the dimmer or switch is in "OFF" mode at 6.5W and in "ON" mode at 16W maximum with full loading.
3. When a dimmer or switch is on the primary (277V) side of the transformer, power is consumed only in "ON" mode to a maximum of 16W under full loading.

Transformer Load - H347 (75VA)

1. H347 Transformer at full loading consumes a maximum of 15W of power
2. When dimmer or switch is on the secondary (120V) side of the transformer, power is consumed by the transformer when the dimmer or switch is in "OFF" mode at 2.5W and in "ON" mode at 15W maximum with full loading.
3. When a dimmer or switch is on the primary (347V) side of the transformer, power is consumed only in "ON" mode to a maximum of 15W under full loading.

Protected / Non-insulated Soffits, Porches, and Canopies

RL7 LED modules when used with Non-IC recessed housings in Non-Insulated protected soffits, porches or canopies offers a solution for outdoor accent lighting. RL7 LED is rated for operation from -30°C to 40°C when used with H7T, H7TNB, H7RT, ET700, ET700R, H750T, H750TCP, H750TD010, H750RTD010, H750TCPD010 Series non-IC housings.

3 YEAR PRODUCT LIMITED WARRANTY

Cooper Lighting (The Company) warrants the RL7x Series LED against defects in material or workmanship for a period of three years from date of original purchase, and agrees to repair or, at the company's option, replace a defective product without charge for either replacement parts or labor during such time. This does not include labor to remove or install fixtures. If used in recessed housings other than Halo or ALL-Pro, the Cooper Lighting 3-year warranty applies to the RL7x LED only.

This warranty is extended only to the original purchaser of the product. A purchasers receipt or other proof of date of original purchase acceptable to the Company is required before warranty performance shall be rendered.

This warranty only covers product failure due to defects in materials or workmanship which occurs in normal use. It does not cover the failure of product caused by accident, misuse, abuse, lack of reasonable care, alteration, or faulty installation, subjecting the product to any but the specified electrical service or any other failure not resulting from defects in materials or workmanship. Damage to the

product caused by separately purchased, non-Company supplied components and corrosion or discoloration of components are not covered by this warranty. There are no express warranties except as described above.

THE COMPANY SHALL NOT BE LIABLE FOR INCIDENTAL, SPECIAL OR CONSEQUENTIAL DAMAGES RESULTING FROM THE USE OF THE PRODUCT OR ARISING OUT OF ANY BREACH OF THIS WARRANTY. ALL IMPLIED WARRANTIES, IF ANY, INCLUDING IMPLIED WARRANTIES OF MERCHANTABILITY AND FITNESS FOR A PARTICULAR PURPOSE, ARE LIMITED IN DURATION TO THE DURATION OF THIS EXPRESS WARRANTY. Some states do not allow the exclusion or limitation of incidental or consequential damages, or limitations on how long an implied warranty lasts, so the above exclusions or limitations may not apply to you.

No other warranty, written or verbal, is authorized by the Company. This warranty gives you specific legal rights, and you may also have other rights which vary from state to state.

To obtain warranty service, please write to Cooper Lighting, 1121 Highway 74 South, Peachtree City, Georgia 30269. Enclose product model number and problems you are experiencing, along with address and telephone number. You will then be contacted with a solution or a Return Goods Authorization number and full instructions for returning the product. All returned products must be accompanied by a Return Goods Authorization Number issued by the Company and must be returned freight prepaid. Any product received without a Return Goods Authorization Number from the Company will be refused.

Cooper Lighting is not responsible for merchandise damaged in transit. Repaired or replaced products shall be subject to the terms of this warranty and are inspected when packed. Evident or concealed damage that is made in transit should be reported at once to the carrier making the delivery and a claim filed with them.

Note: Specifications and Dimensions subject to change without notice.

Visit our web site at www.cooperlighting.com